

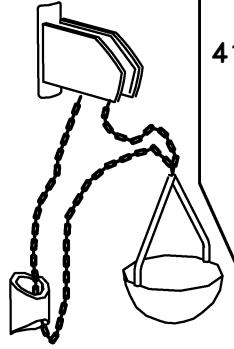

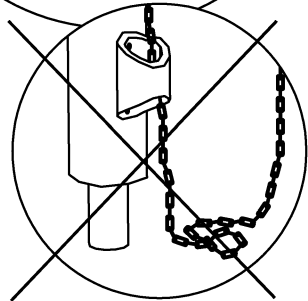

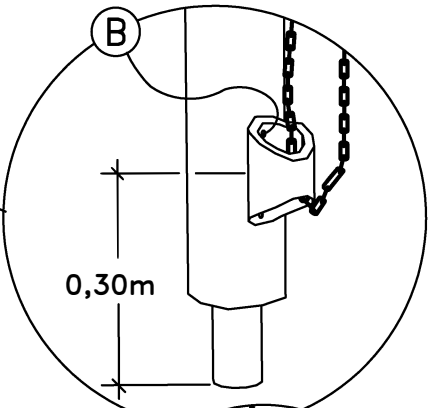

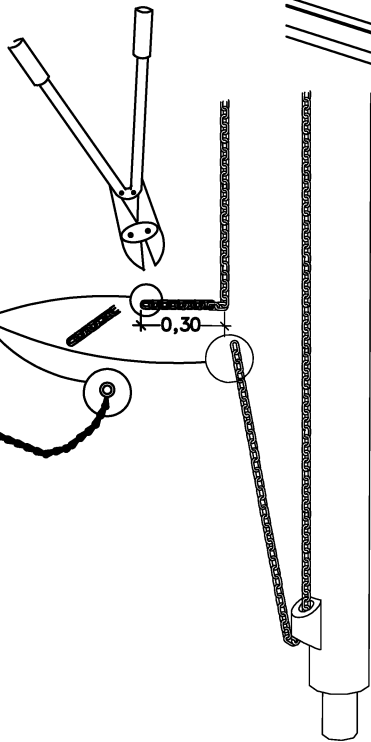
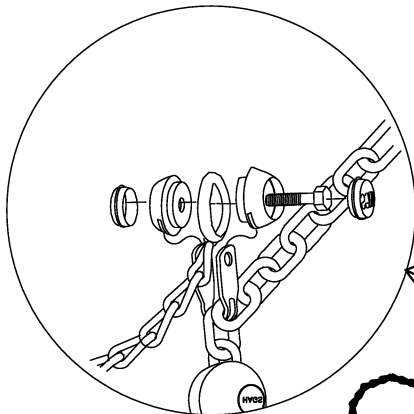
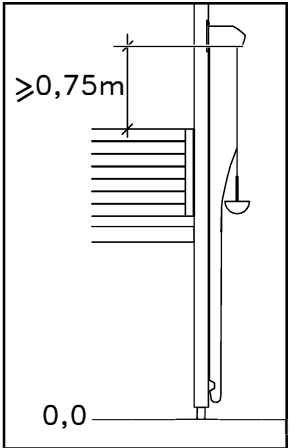

TYPE	HAGS.NO
	410816-02



A	COVER 6 (261801)	SRB 6x14 (326016)	 CAP 6 (261803)
	 TKFT 6x50 (311102)		

B	 FXS 6x45 (311610)	 PLB (260469)
---	---	--

<b>HAGS</b>		ANEBY, SWEDEN +46(0)380-47300 www.hags.com	
Elevator Head			
6816			
1(1)			
	ACJ		TJ   2010-01-12   7