

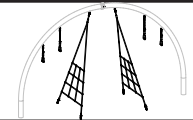





CC

	DocID		QTY	Name
1	78601013		1	Sierra Diablo
2	78601008		1	Okavango Swamp
3	78601024		1	Yukon log Roll
4	PCBOL 200		1	Stepping Bollard
5	PCBOL 300		3	Stepping Bollard
6	PCBOL 400		5	Stepping Bollard
7	PCBOL 500		1	Stepping Bollard

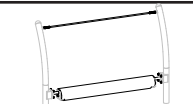

S6

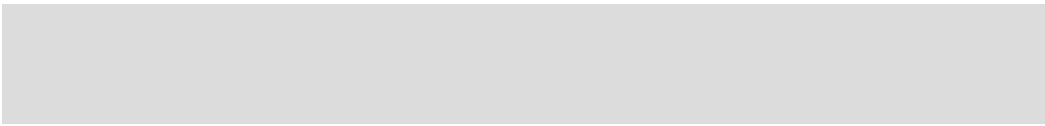
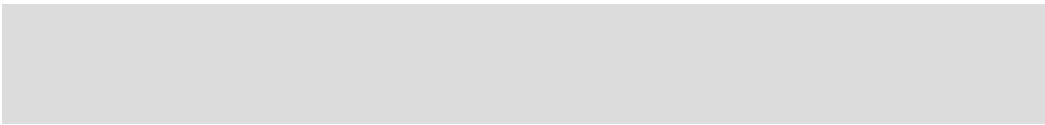
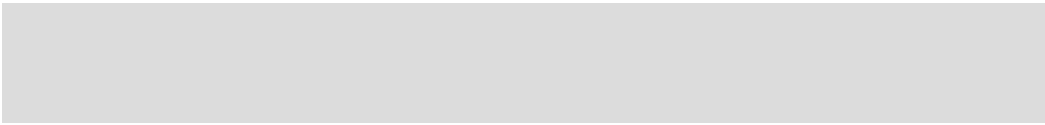
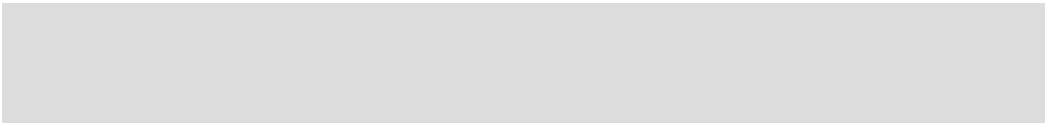
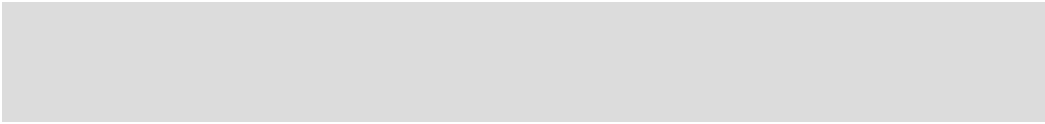
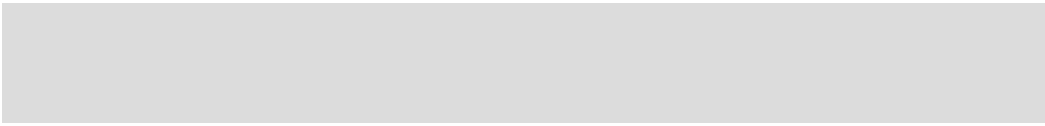
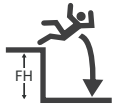

EN1176

1.75m

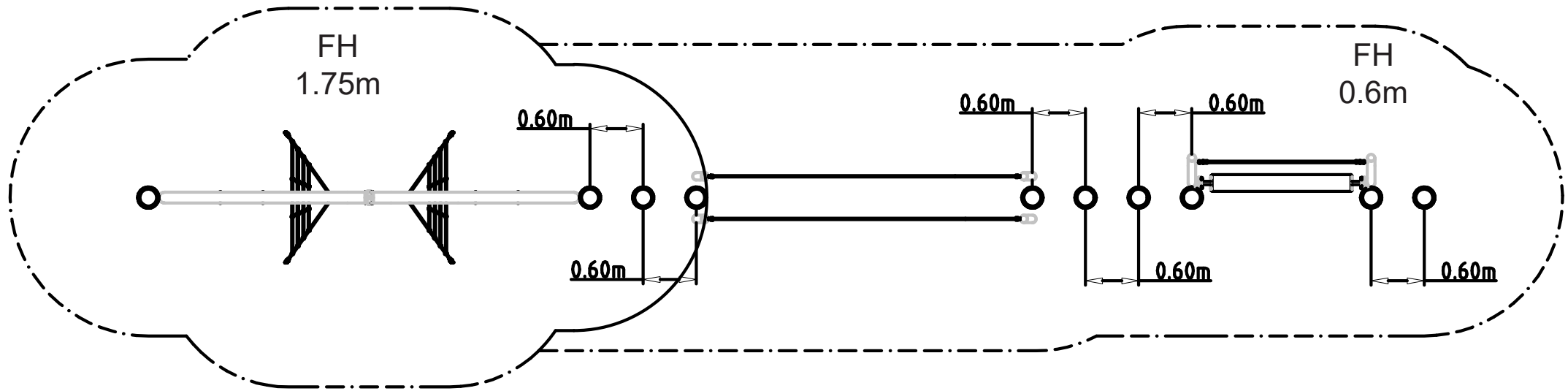

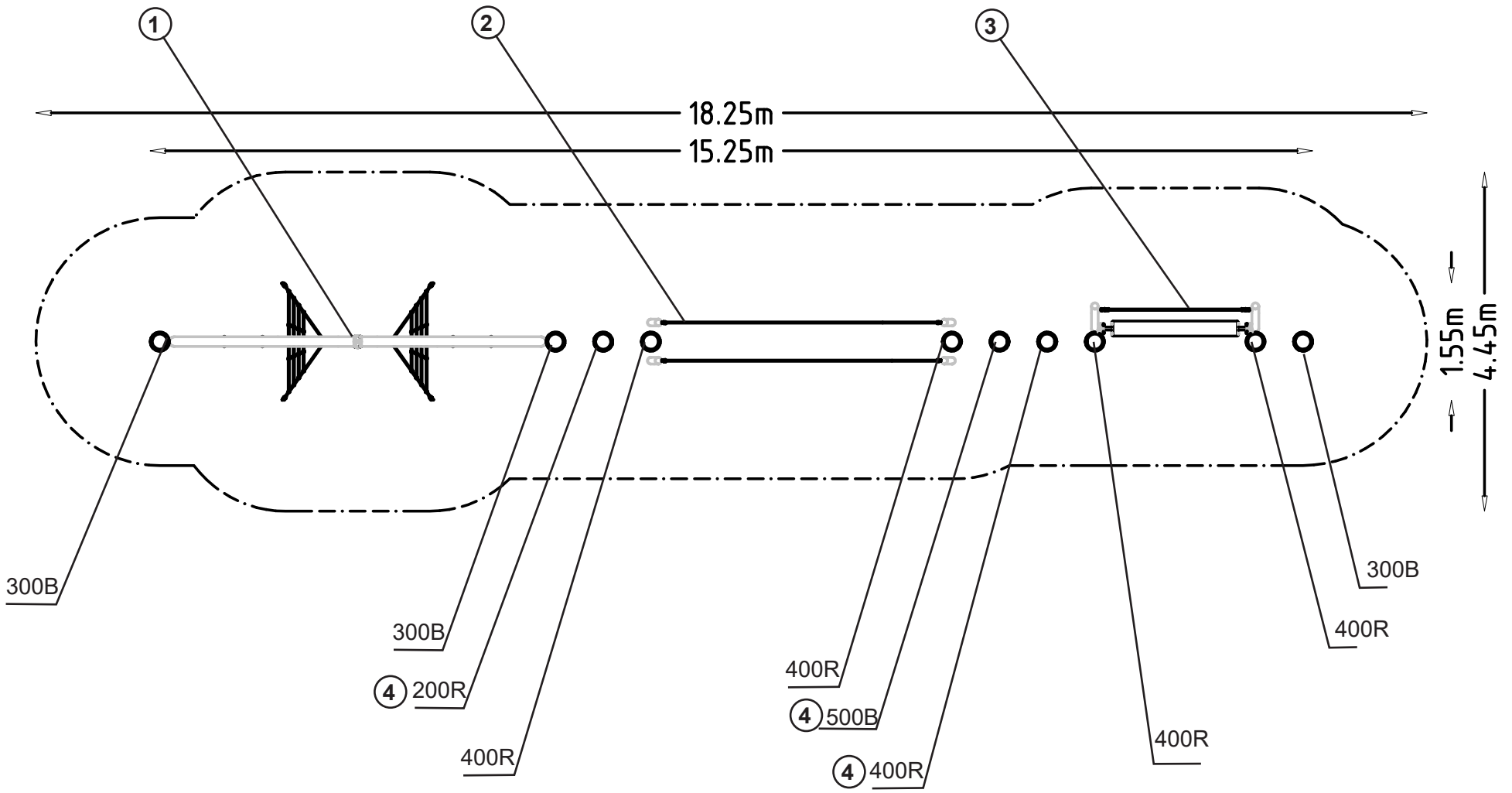

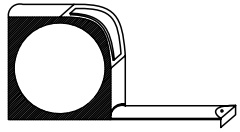

	A	B
A	0.00	18.25
B	18.25	0.00
1	2.69	16.56
2	6.92	11.79
3	8.07	10.38
4	12.02	6.54
5	13.89	4.36
6	16.00	2.25

