

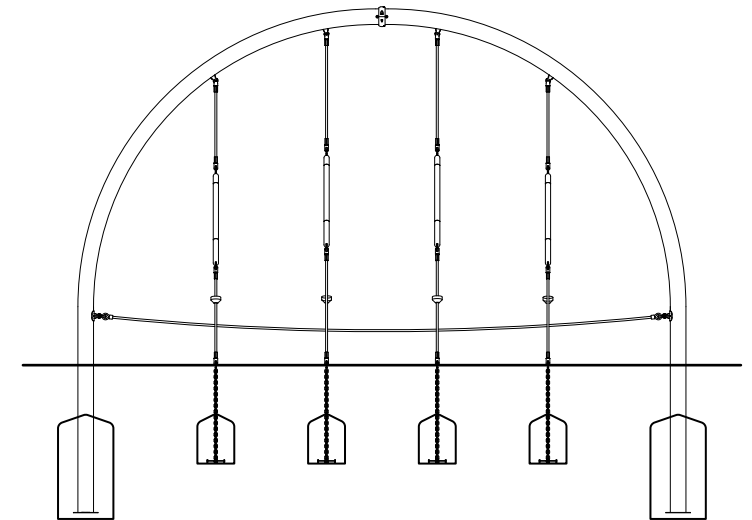









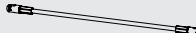
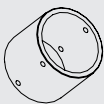
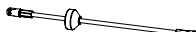

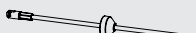

CC & BM

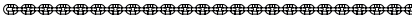
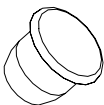
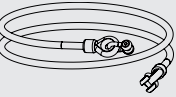
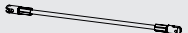

1	78603013		x2	51Kg	4800x 1310 x 200mm	11	78805070		Ø16 x 792mm	x2	0.5Kg
2	78604001		x1	2.2g	Ø118 x 100mm	12	78805071		Ø16 x 792mm	x2	0.55Kg
3	10291000		x4	0.002Kg	M10_B_Ø11 x Ø21 x 1_A2	13	78805073		Ø16 x 941mm	x2	0.6Kg
4	10121030		x4	0.03Kg	M10 x 30_A2_TX45	14	78805072		Ø16 x 941mm	x2	0.55Kg
5	78804306		x2	0.27Kg	5" - 163 x 84 x 51	15	109309		Ø7 x 69 x 34 x 11mm	x8	0.06Kg
6	14104749		x2	0.01Kg	1/4" UNC x 1-1/4"	16	38008027		Ø8 x 1150mm	x8	1.70Kg
7	19055030		x2	0.001Kg	Ø11.5 x 9.5	17	78805061		Ø16 x 4580mm	x1	12kg
8	78805030		x2	0.50Kg	Ø16 x 708mm	18	78804031			x1	
9	78805031		x2	0.55Kg	Ø16 x 937mm						
10	78803042		x4	7.75Kg	Ø43 x 850 x 820mm						

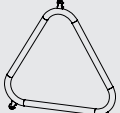
S12



kg

168

S15

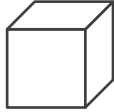

L x W x H (m)

4.94 x 1.08 x 2.91

S13



m³

0.67

S14



m²

10 x 10

S6

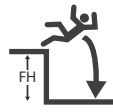

EN1176

1.7m

S20



2 x 8



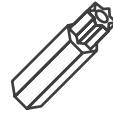

S24

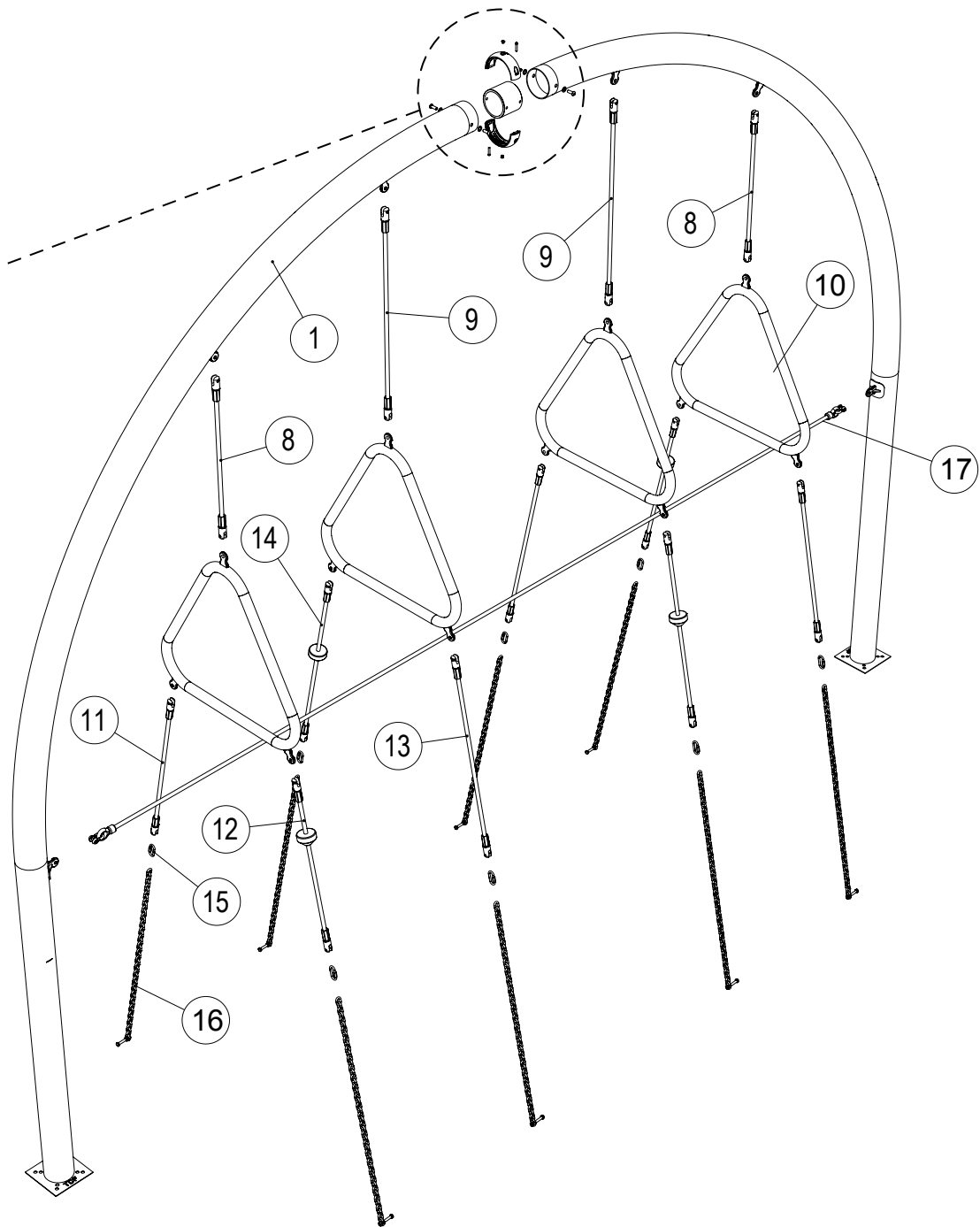
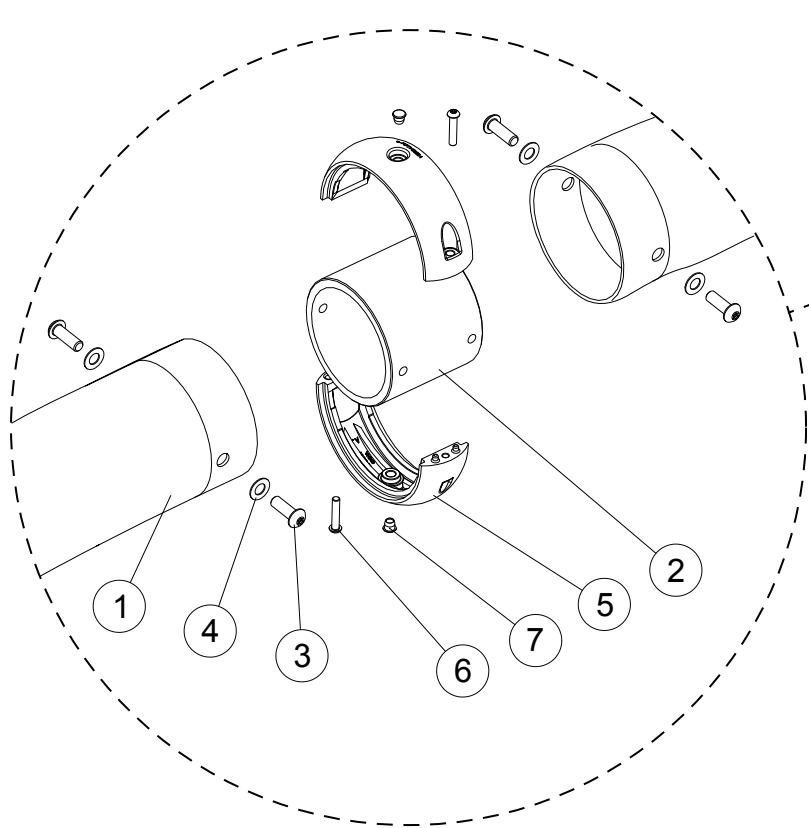

10121000 - TX45



GB - Verify ropes fit – remove before concreting
ES – Utilizar las cuerdas para verificar la distancia entre los postes - quitarlas antes de poner el hormigón
FR – Utiliser les cordes pour vérifier la distance entre les poteaux - les retirer avant bétonnage
DE – Überprüfen Sie, dass die Seile passen - vor der Betonierung
IT – Usare le corde come distanziali – rimuoverle prima di cementare i pali
SE – Kontrollera att de linorna passa - flyttas innan betongarbete

S25	
S2 (50mm)	
≥C20-25	
 7 x 24h	
 101	
S13	
m ³	
0.67	

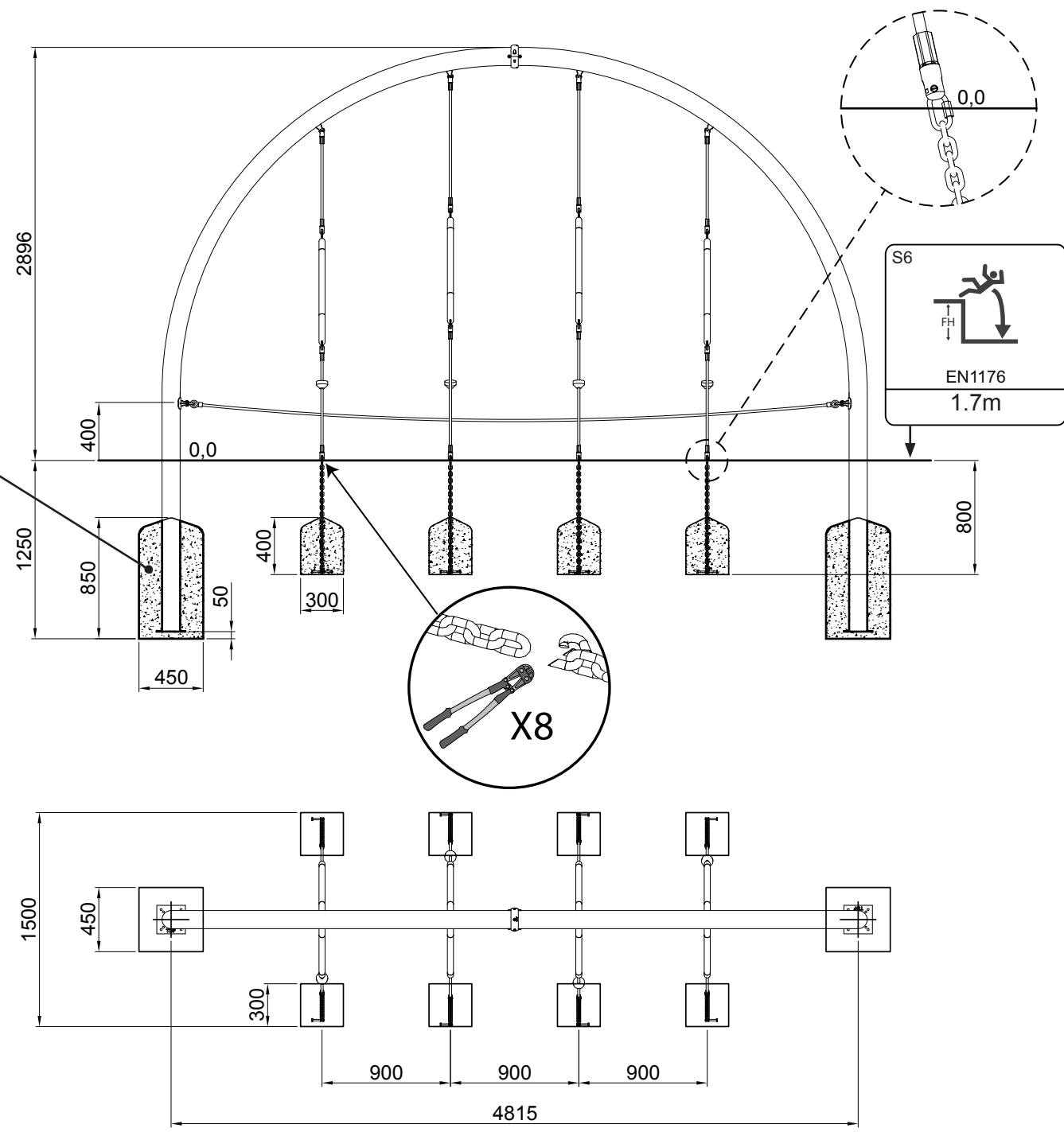

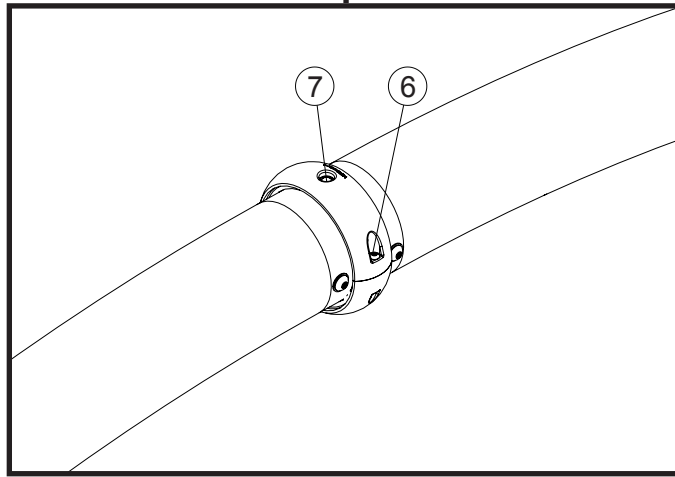
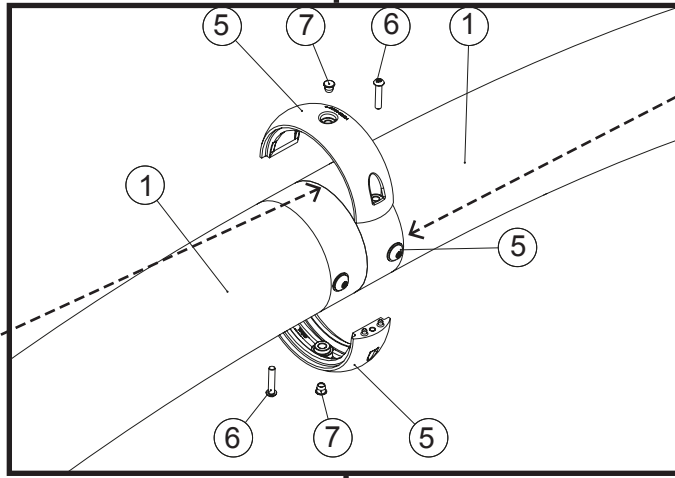
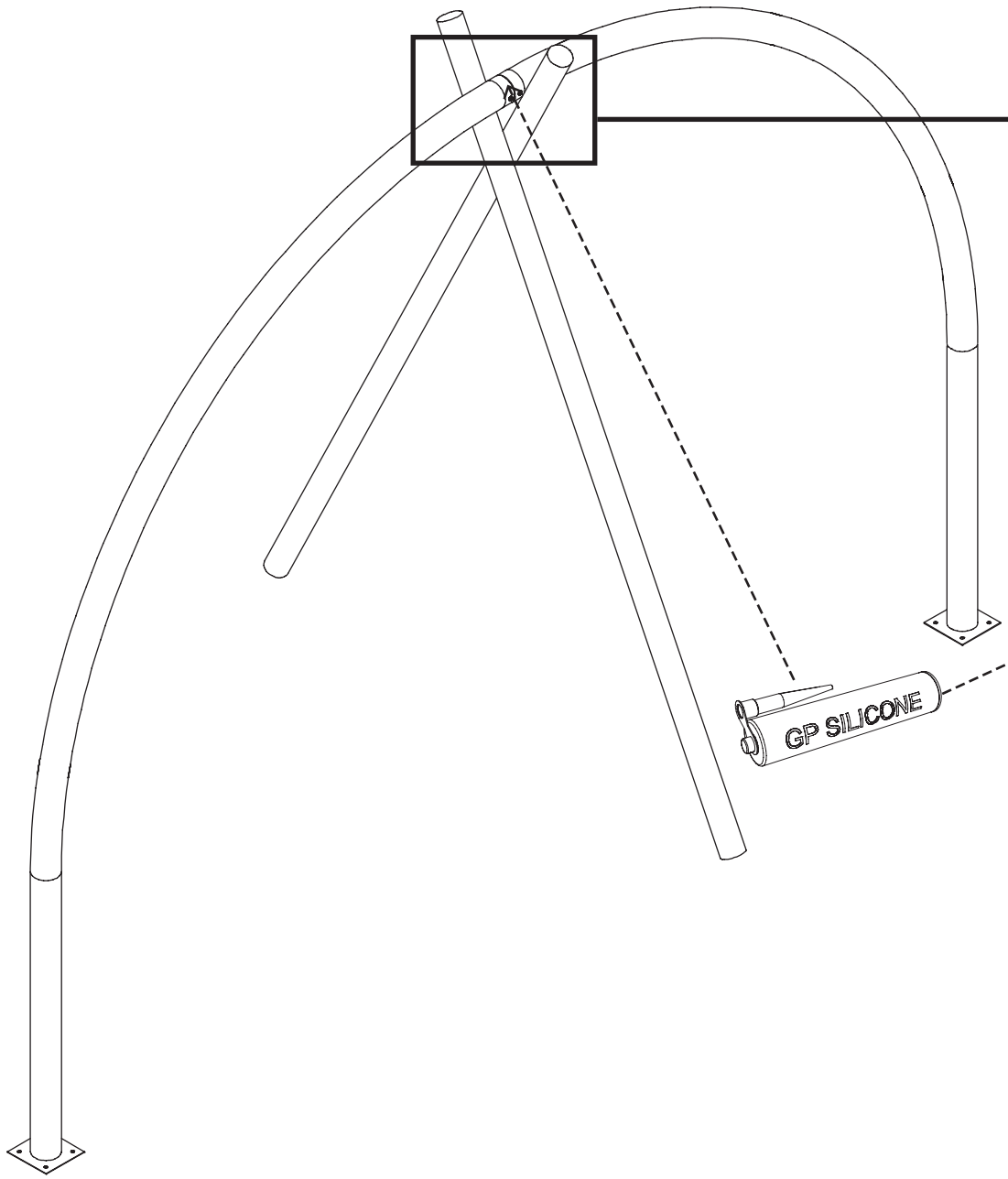

S11



Nm
20-25

