

HAGS[®]

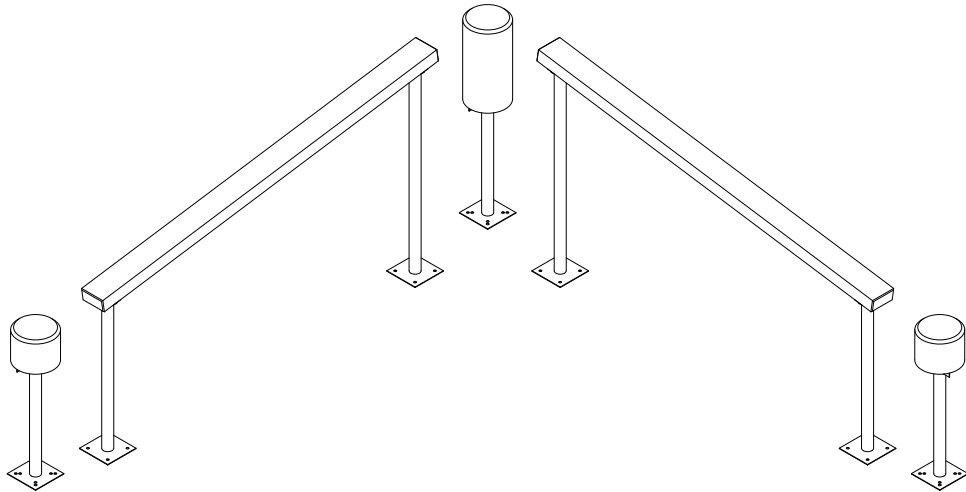



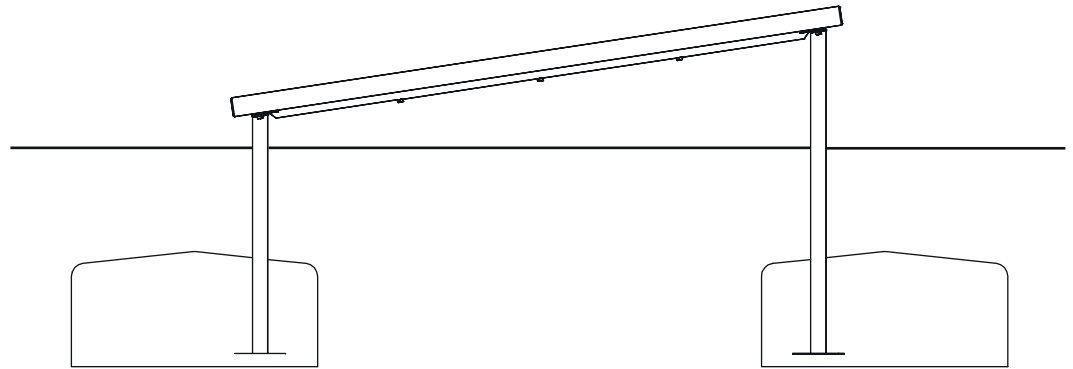

NRG Klondike Double

MA78601026

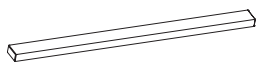

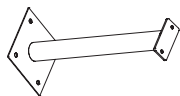

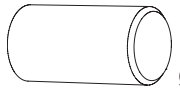
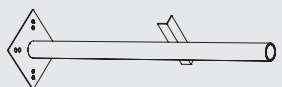
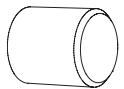
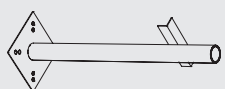

CC & BM

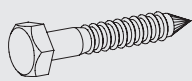
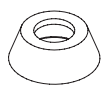

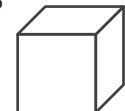
1	78804006		2400 x 150 x 75mm	x2	8Kg
2	78803004		2260 x 130 x 30mm	x2	1kg
3	78803034		935 x 200 x 200mm	x2	7.4kg
4	78803035		1265 x 200 x 200mm	x2	9.8Kg
5	RYBL500		Ø250 x 500mm	x1	23.2Kg
6	803705		1120 X 200 x 200mm	x1	8.84Kg
7	RYBL200		Ø250 200mm	x2	9.33Kg
8	803702		820 X 200 x 200mm	x2	6.8Kg
9	RYADHBK		ARO-SEAL 1132 www.thenamethatsticks.com/products/?qt=Sealant	x1	

10	10211060		Ø10 x 70mm	x14	0.05kg
11	10301002		Ø27 x Ø20 x 10mm	x14	0.01Kg

S12  kg 114	S15  L x W x H (m) 3.45 x 3.45 x 0.55	S13  m ³ 1.3	S14  m ² 10 x 10
S6  EN1176 0.6m	S20  2 x 6		

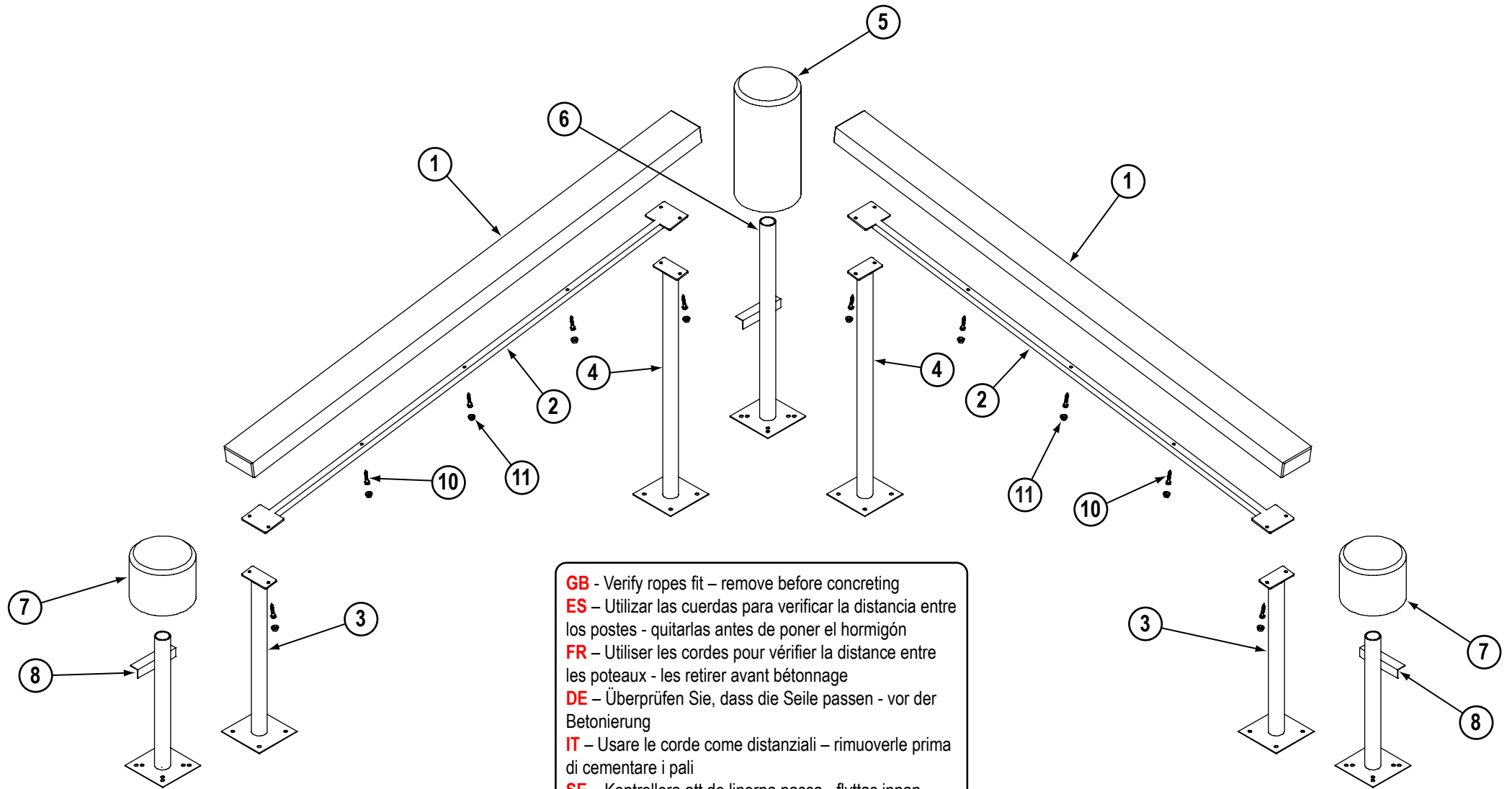

GB - Verify ropes fit – remove before concreting
ES – Utilizar las cuerdas para verificar la distancia entre los postes - quitarlas antes de poner el hormigón
FR – Utiliser les cordes pour vérifier la distance entre les poteaux - les retirer avant bétonnage
DE – Überprüfen Sie, dass die Seile passen - vor der Betonierung
IT – Usare le corde come distanziali – rimuoverle prima di cementare i pali
SE – Kontrollera att de linorna passa - flyttas innan betongarbete

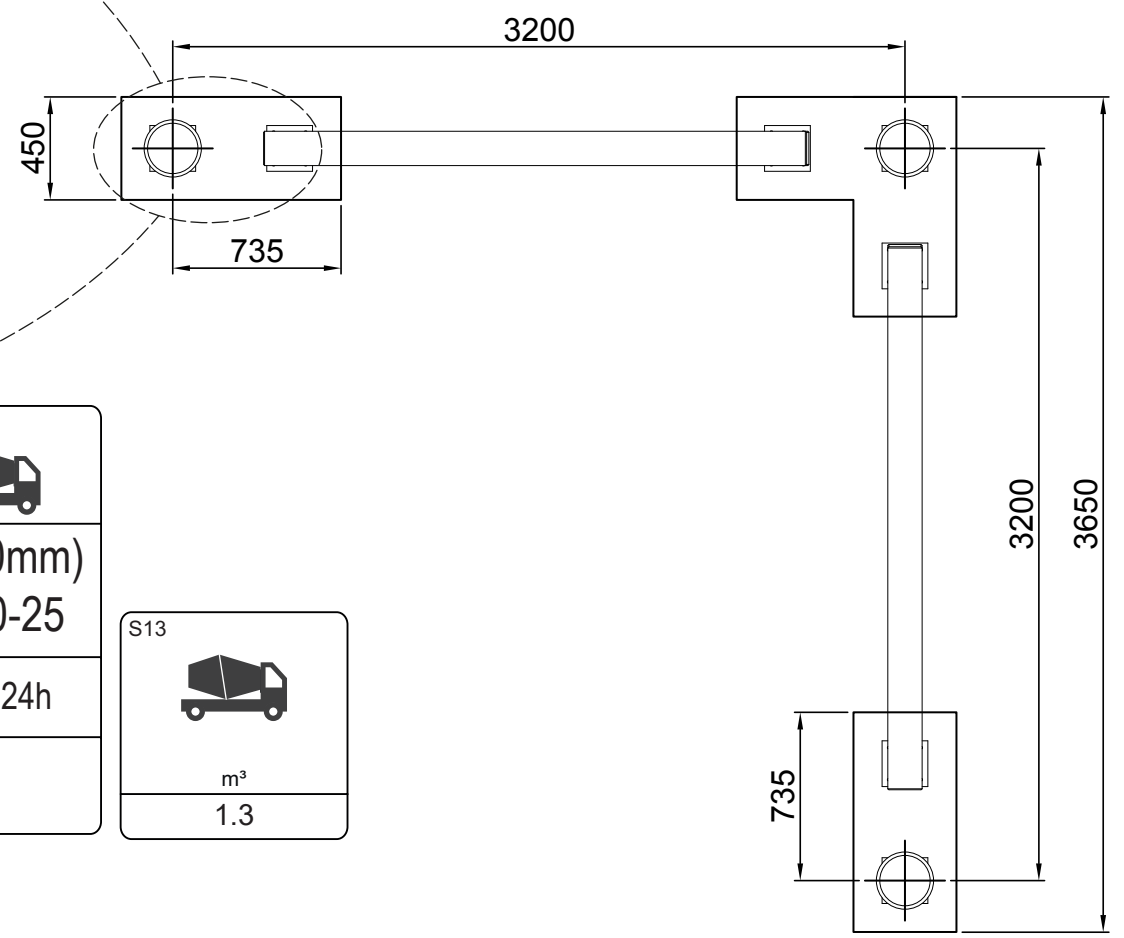
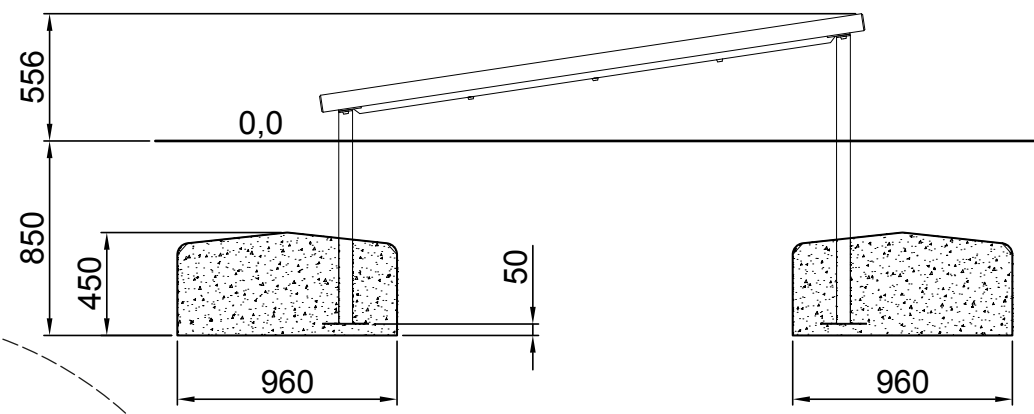
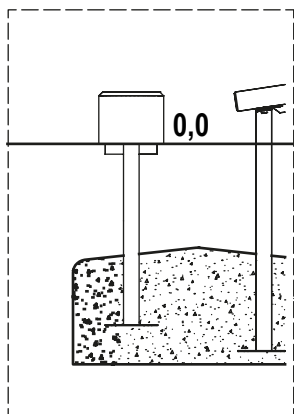
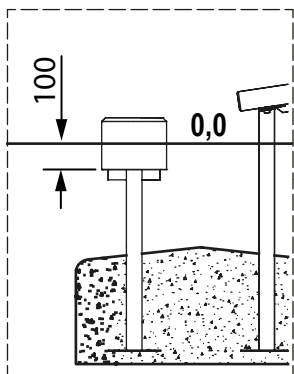

S25

S2 (50mm)
≥C20-25

7 x 24h

101

S13

m³
1.3

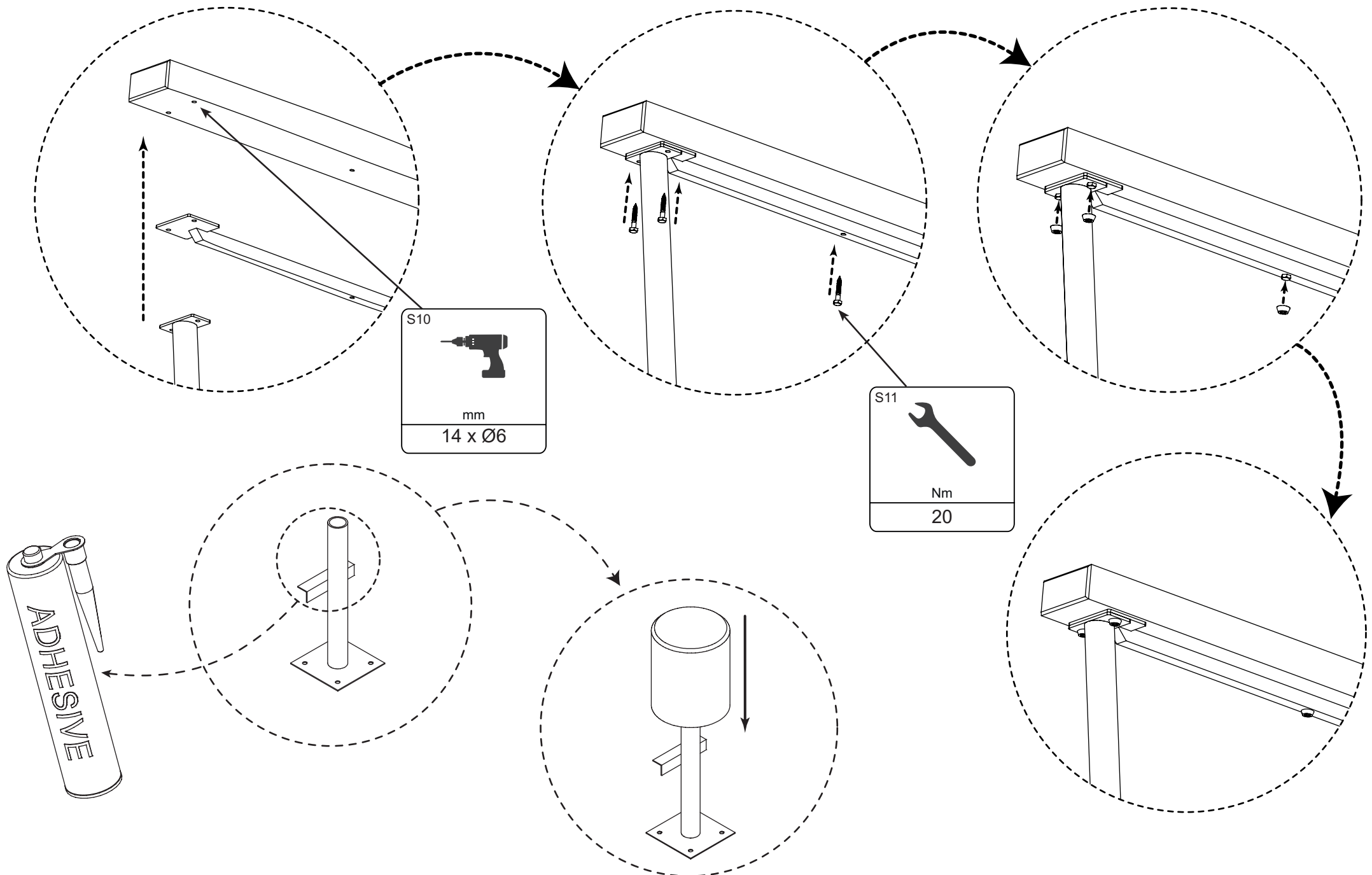

S10

 mm
 14 x Ø6

S11

 Nm
 20

