

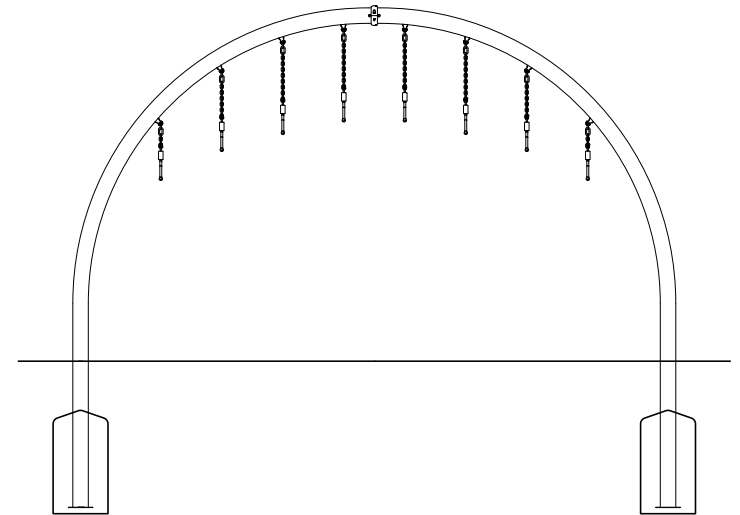

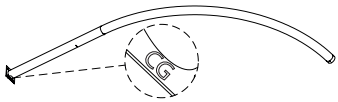

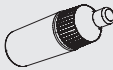

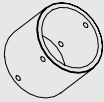





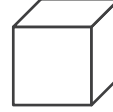



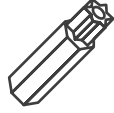

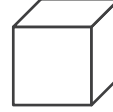



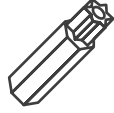

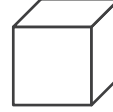



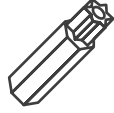

### CC & BM

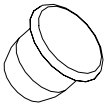

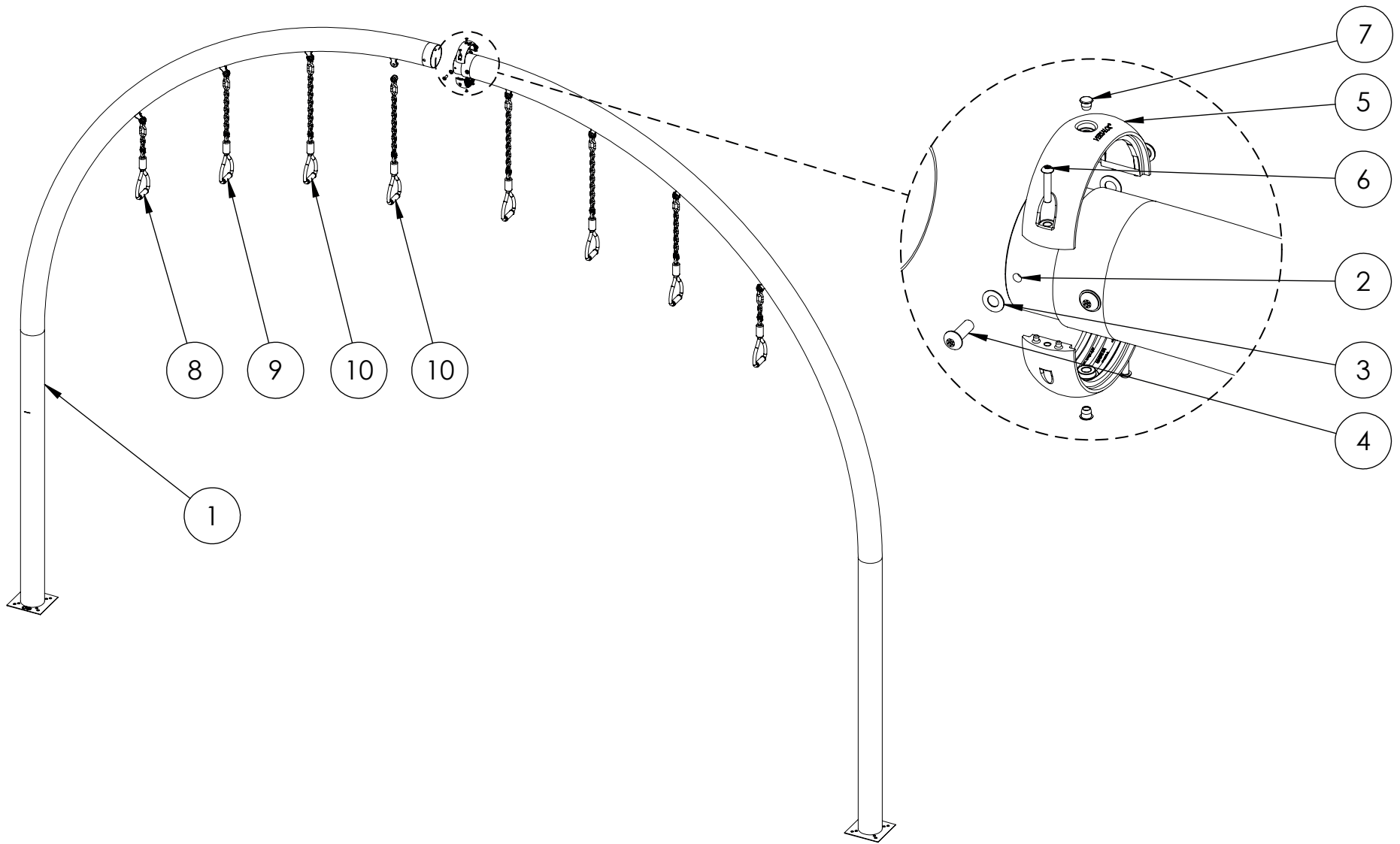

1	78603011		4800x 1310 x 200mm	x2	51Kg	11	950040		x1																																														
2	78604001		Ø118 x 100mm	x1	2.2g	12	78804031		x1																																														
3	10291000		M10_B_Ø11 x Ø21 x 1_A2	x4	0.002Kg	<table border="1"> <tr> <td>S12</td> <td></td> <td>S15</td> <td></td> <td>S13</td> <td></td> <td>S14</td> <td></td> </tr> <tr> <td>kg</td> <td>L x W x H (m)</td> <td>m<sup>3</sup></td> <td>m<sup>2</sup></td> <td colspan="4"></td> </tr> <tr> <td>112</td> <td>4.94 x 0.13 x 2.91</td> <td>0.35</td> <td>10 x 10</td> <td colspan="4"></td> </tr> <tr> <td>S6</td> <td></td> <td>S20</td> <td></td> <td>S24</td> <td></td> <td colspan="2"></td> </tr> <tr> <td>EN1176</td> <td>2 x 6</td> <td>10121000 - TX45</td> <td colspan="2"></td> <td colspan="2"></td> </tr> <tr> <td>2.0m</td> <td colspan="2"></td> <td colspan="4"></td> </tr> </table>				S12		S15		S13		S14		kg	L x W x H (m)	m <sup>3</sup>	m <sup>2</sup>					112	4.94 x 0.13 x 2.91	0.35	10 x 10					S6		S20		S24				EN1176	2 x 6	10121000 - TX45					2.0m						
S12		S15		S13						S14																																													
kg	L x W x H (m)	m <sup>3</sup>	m <sup>2</sup>																																																				
112	4.94 x 0.13 x 2.91	0.35	10 x 10																																																				
S6		S20		S24																																																			
EN1176	2 x 6	10121000 - TX45																																																					
2.0m																																																							
4	10121030		M10 x 30_A2_TX45	x4	0.03Kg																																																		
5	78804306		5" - 163 x 84 x 51	x2	0.27Kg																																																		
6	14104749		1/4" UNC x 1-1/4"	x2	0.01Kg																																																		
7	19055030		Ø11.5 x 9.5	x2	0.001Kg																																																		
8	78801012		140 x 38 x 456mm	x2	0.60Kg																																																		
9	78801011		140 x 38 x 647mm	x2	0.82Kg																																																		
10	78801010		140 x 38 x 743mm	x4	0.95Kg																																																		



S25

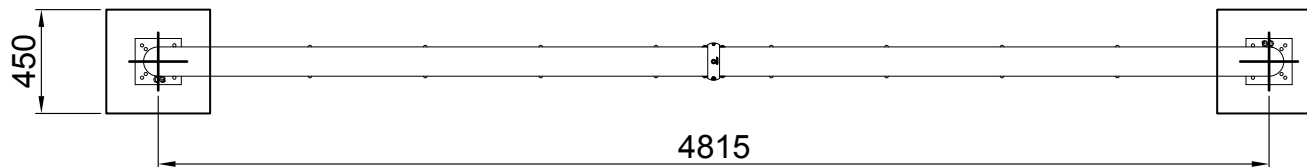
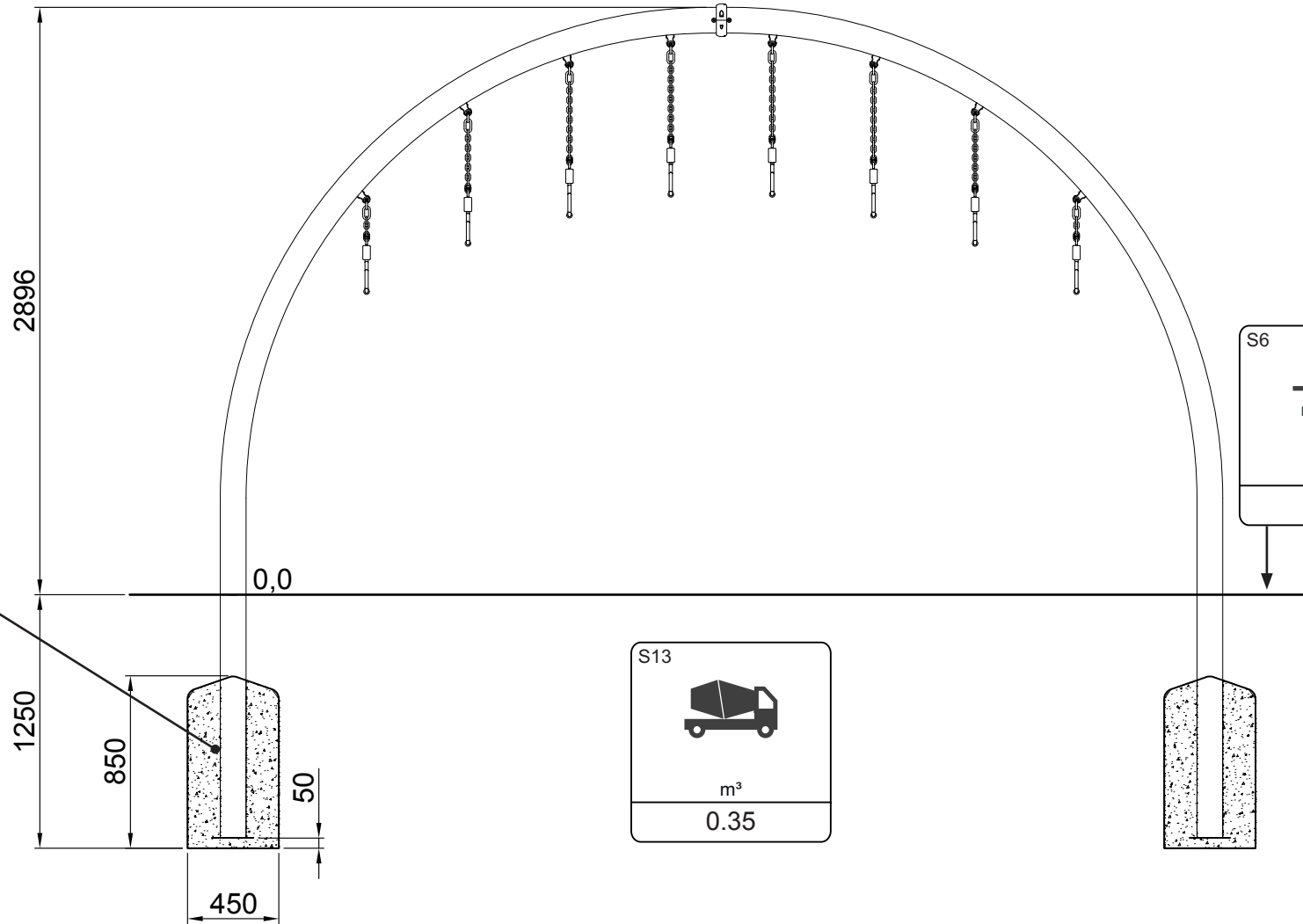

S2 (50mm)  
≥C20-25

 7 x 24h
   
 101

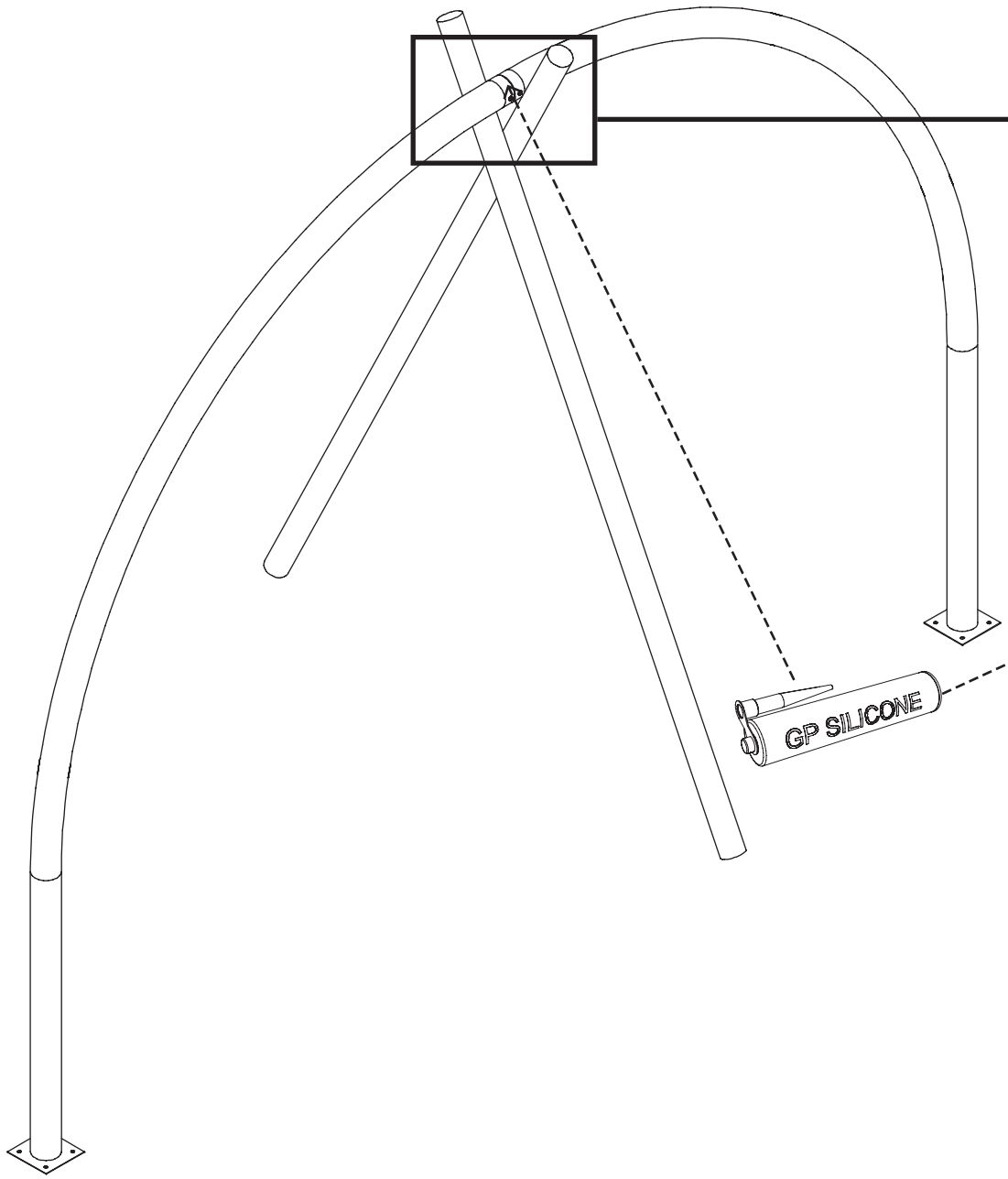

GP SILICONE

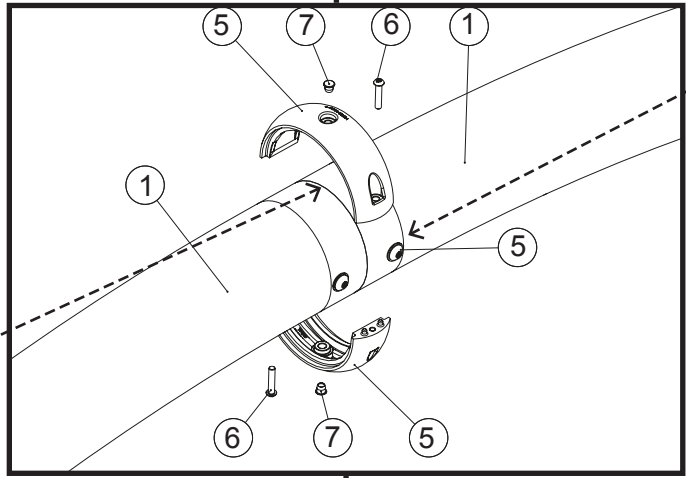

S11



Nm  
20-25

