

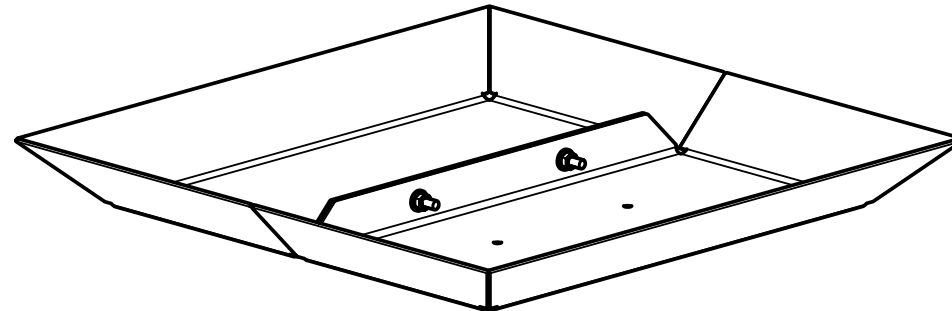

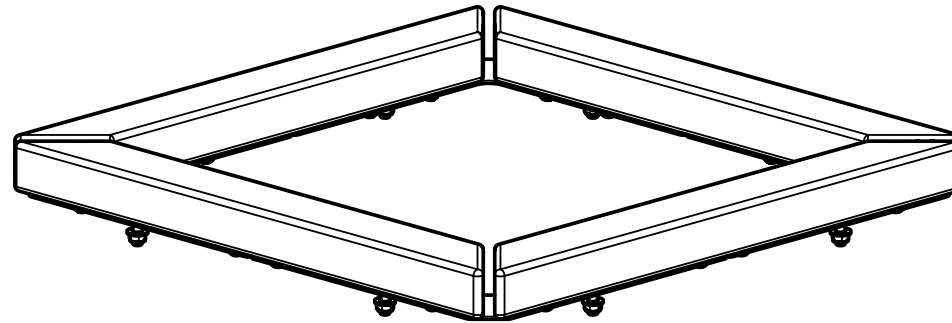
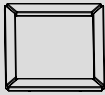

# HAGS<sup>®</sup>

## Square Wood Frame & Bottom Plates

MASW78080



1	SW78080		1x 600 x 600 x 30	4.74kg
2	8008795		10x Nut, Fujilok-M8-8-RingA2	0.01kg
3	8008849		12x Washer, Bolt cap 9x18x2-ISO4759-3-C	0.01kg
4	SW100130		2x 600 x 300 x 60	4.95kg
5	8008445		2x Screw, ISO7380-1-M8x30-10.9	0.02kg

