

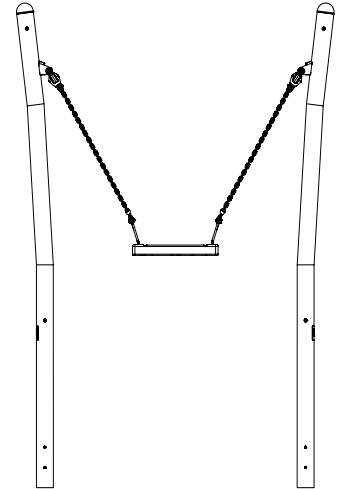











CC



1	43-04818		4x CAP 10, Ø17x14,5 mm	0.01kg
2	43-04820		4x Cover 10, Ø25x12mm	0.00kg
3	8008796		2x Nut, Fujilok-M10-8-RingA2	0.011kg
4	8019919		4x Ø10 x 400 mm	0.00kg
5	SW68067		1x	5.40kg
6	SW75574		2x	49.18kg
7	SW84435		2x	0.93kg
8	8008383		2x Screw, ISO4014-M10x60-8.8	0.0479kg
9	8008502		8x Screw, ISO7380-1-M8x20-10.9	0.011kg
10	8071044		4x Washer ISO7092-10.5x18.1.6	0.002kg
11	43-04821		2x Ø10,5x34x4 mm	0.00kg



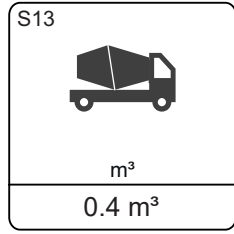
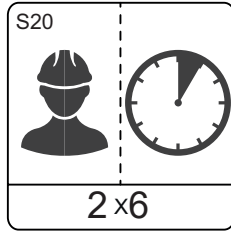
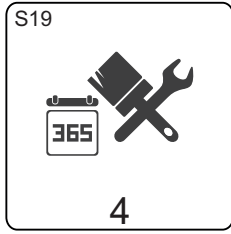
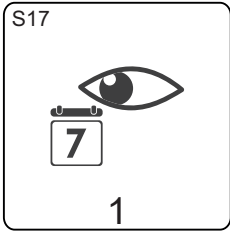
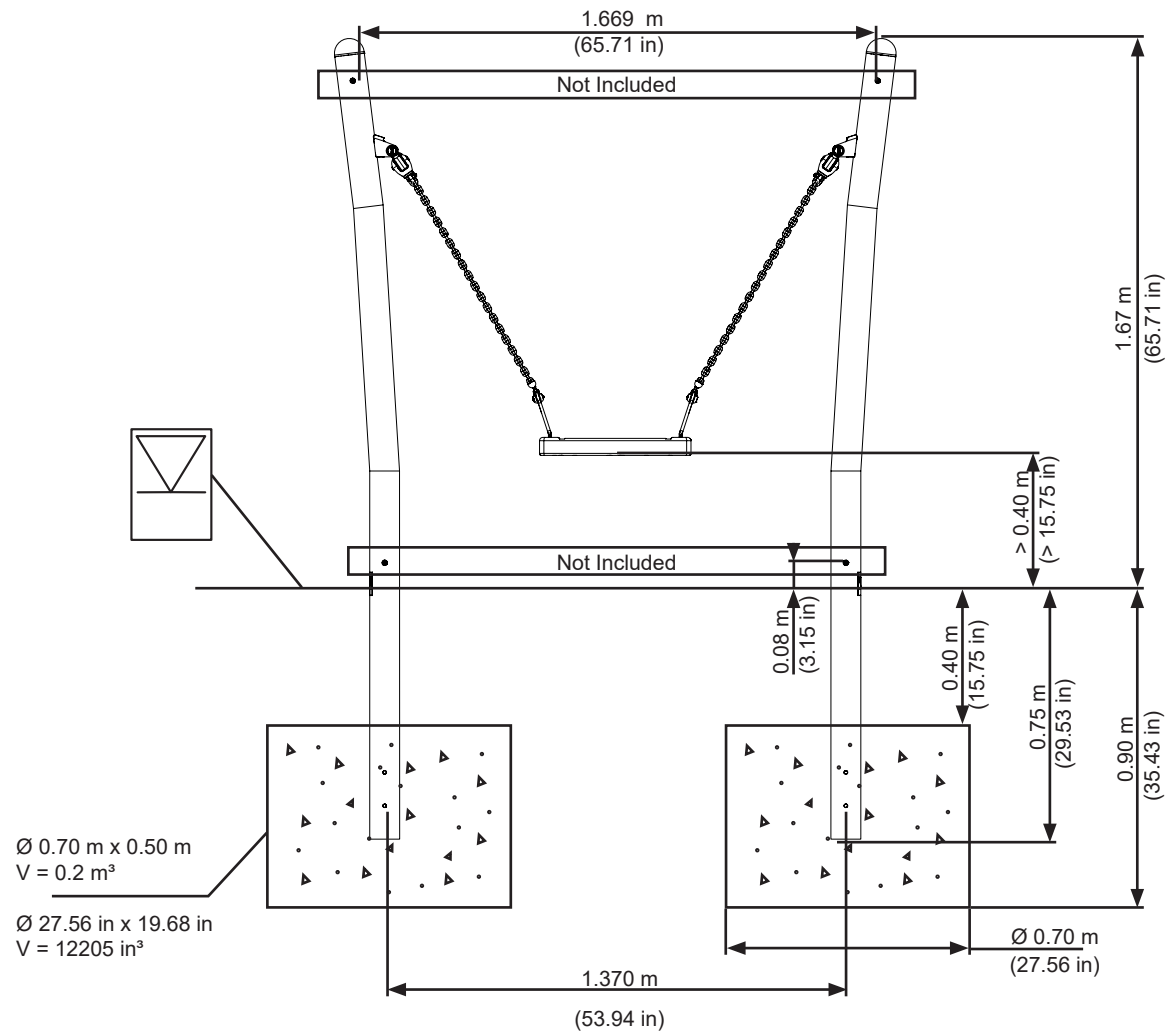

$\varnothing 0.70 \text{ m} \times 0.50 \text{ m}$
 $V = 0.2 \text{ m}^3$
 $\varnothing 27.56 \text{ in} \times 19.68 \text{ in}$
 $V = 12205 \text{ in}^3$

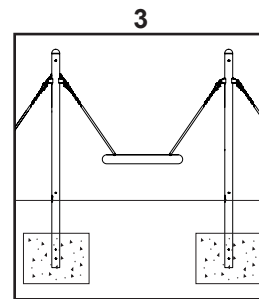
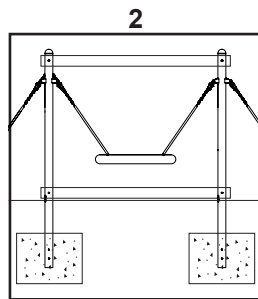
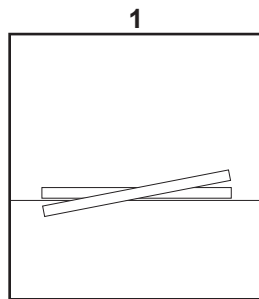

S25	
0.4 m ³	
	7 x 24
	101

