











BOM ID	IMAGE	QUANTITY	DESCRIPTION	DOCUMENT ID	WEIGHT
1		1	Kiddy R&T	SW31746	5.15
2		2	Y-Chain Covered 6mm	SW32687	0.83
3		2	Concrete base	SW42011	12.29
4		1	Swingjoint compl. Mid post f. Lillie	SW63646	3.88
5		1	Swing leg w. Foot S	SW64171	25.09
6		1	Adapter f. Expansion	SW64307	11.72
7		1	Mid anchor beam, Anchoring S	SW68047	12.22
8		16	Nut, ISO7042-M10-8	8042810	0.012
9		4	U-schackle	SW20172	0.02
10		10	Screw, ISO4017-M10x25-8.8	8008371	0.0263
11		18	Washer ISO7089-10.5x20x2	8050050	0.004





Lillie Expansion module w Kiddy in combination with Kiddy

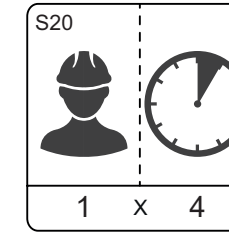
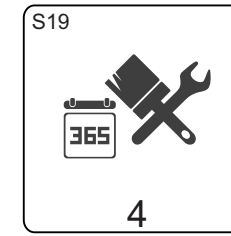
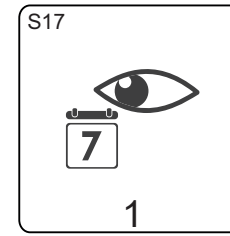
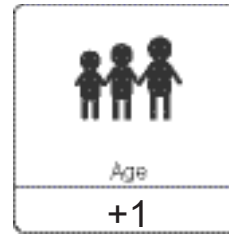
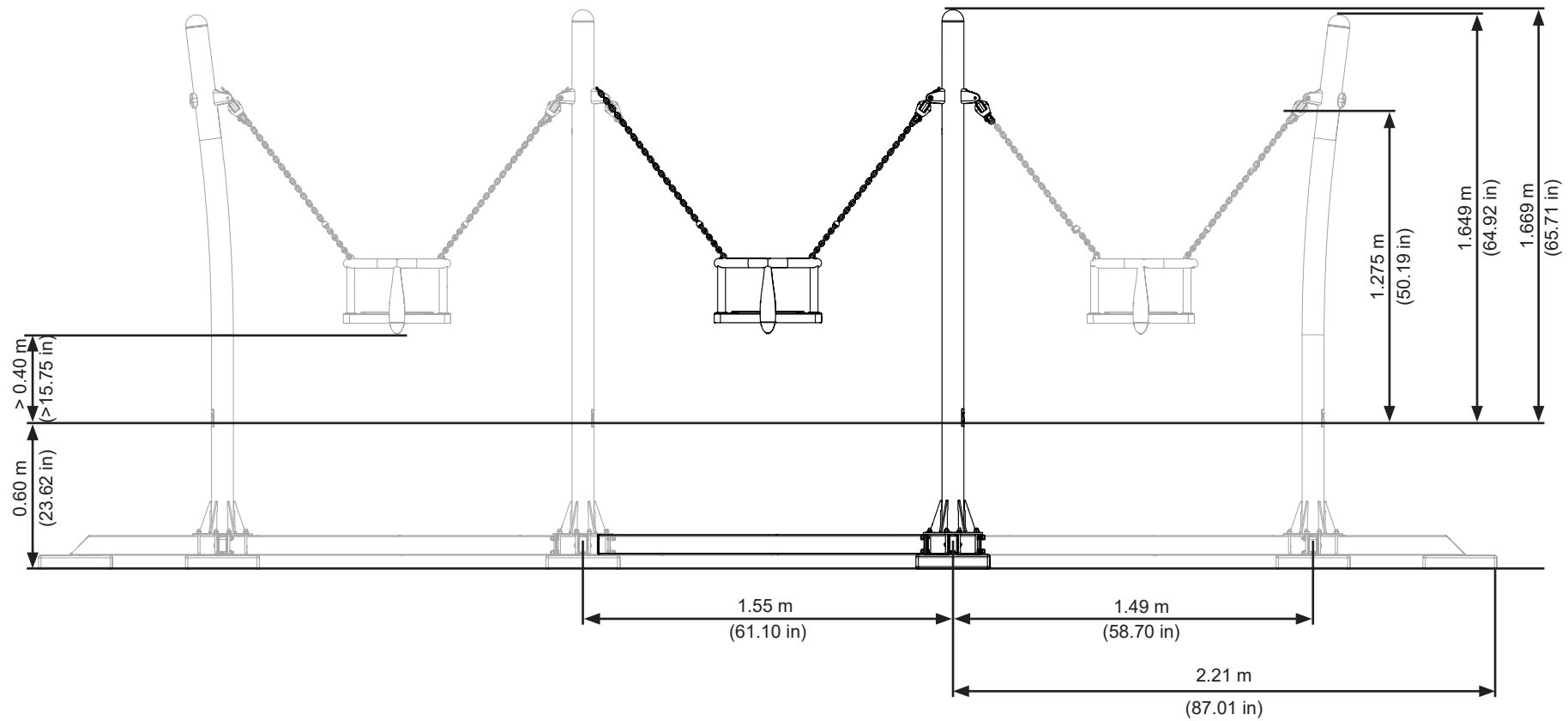
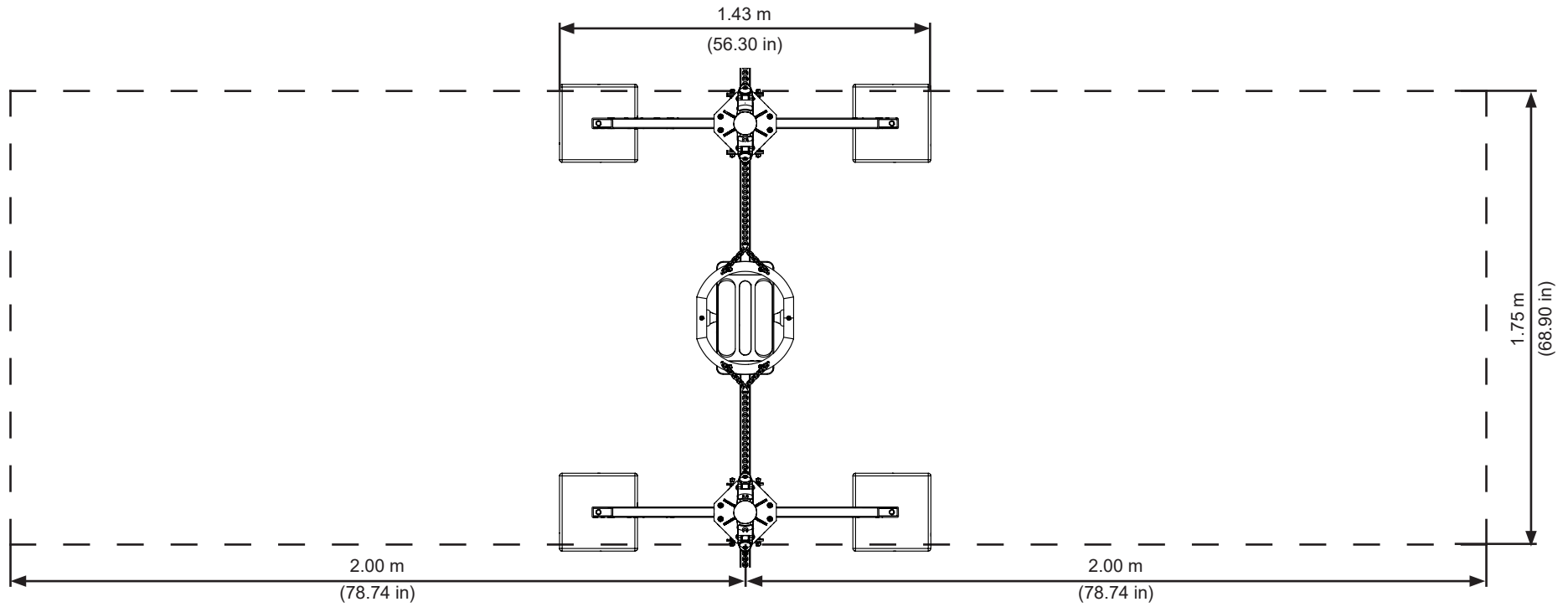
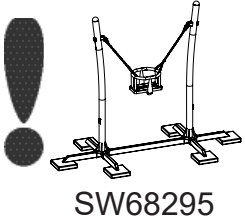

Lillie Expansion module w Kiddy in combination with Katja or Dolly

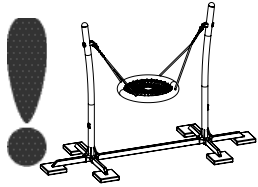

SW63893

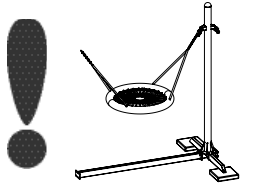

SW68186

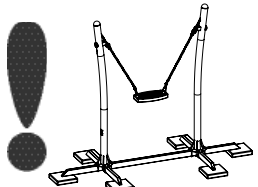

SW68277

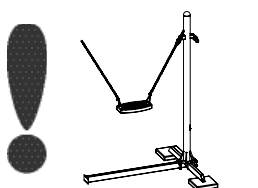

SW68279

