

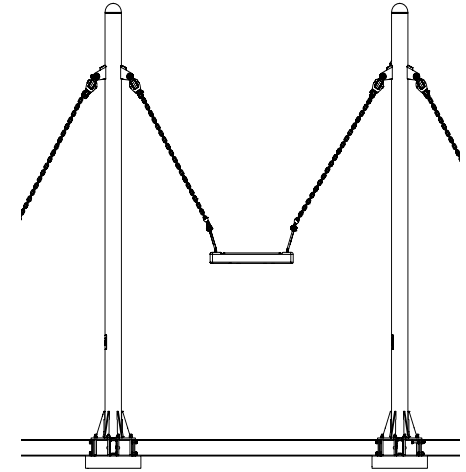













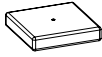

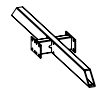

S

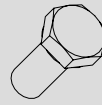

1	43-04818		4x	CAP 10, Ø17x14,5 mm	0.01kg
2	43-04820		4x	Cover 10, Ø25x12mm	0.00kg
3	8008796		2x	Lock Nut M10	0.00kg
4	8042810		16x	Nut, ISO7042-M10-8	0.012kg
5	SW20172		4x		0.02kg
6	SW42011		2x	300 x 300 x 60 mm	12.42kg
7	SW68047		1x		12.22kg
8	SW64307		1x		20.74kg
9	SW68067		1x		5.36kg
10	SW75534		1x		25.62kg
11	SW84435		2x		0.93kg
12	8008383		2x	Screw, ISO4014-M10x60-8.8	0.0479kg



13	8008371		10x	Screw, ISO4017-M10x25-8.8	0.0263kg
14	8050050		18x	Washer ISO7089-10.5x20x2	0.004kg
15	8071044		4x	Washer ISO7092-10.5x18.1.6	0.002kg
16	43-04821		2x	Ø10,5x34x4 mm	0.00kg



Age



3-12

S17



1

S19

4

S20

1 x 4

