

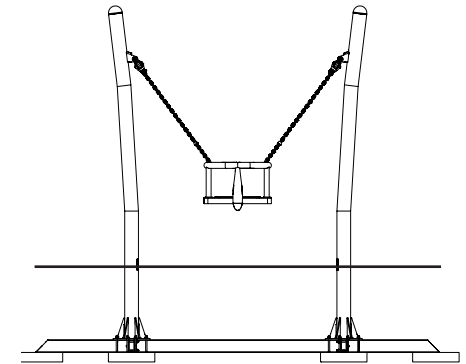











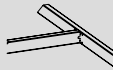

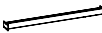

**S**



1	43-04818		4x	CAP 10, Ø17x14,5 mm	0.01kg
2	43-04820		4x	Cover 10, Ø25x12mm	0.00kg
3	8008796		2x	Nut, Fujilok-M10-8-RingA2	0.011kg
4	8042810		24x	Nut, ISO7042-M10-8	0.012kg
5	SW20147		2x	1180 x 640 mm	22.98kg
6	SW20172		8x		0.02kg
7	SW42011		6x	300 x 300 x 60 mm	12.42kg
8	SW68047		1x		12.22kg
9	SW31746		1x	Kiddy R&T	5.15kg
10	SW84435		2x		0.93kg
11	SW86352		2x		25.21kg
12	8008383		2x	Screw, ISO4014-M10x60-8.8	0.0479kg

13	8008373		6x	Screw, ISO4017-M10x30-8.8	0.0294kg
14	8050050		30x	Washer ISO7089-10.5x20x2	0.004kg
15	8071044		4x	Washer ISO7092-10.5x18.1.6	0.002kg
16	43-04821		2x	Ø10,5x34x4 mm	0.00kg
17	SW32687		2x		0.83kg

S17



1

S19



4

S20



1 x 4

