

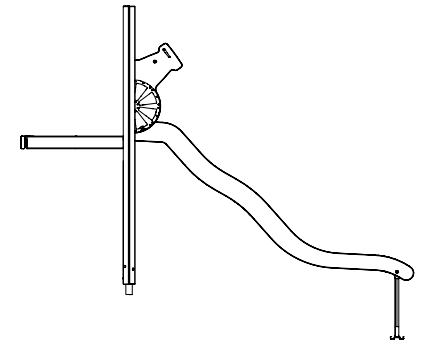























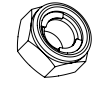





**S**



BOM ID	IMAGE	QUANTITY	DESCRIPTION	DOCUMENT ID	WEIGHT
1		1	HPL-slide 0,45x2,6m	31-06265	34.62
2		1	Floor Fitting	32-03127	2.17
3		1	Handle/footrest Threaded	43-05006	0.28
4		1	Start part, right	SW45583	6.36
5		1	Start part, left	SW45583	6.36
6		1	Padding Left	SW54346	3.19
7		1	Padding Right	SW54350	3.19
8		1	Ground Arch	33-04153	-
9		1	Ground bar- UniMini	33-05371	2.18
10		4	Cover cap M6	43-04810	0.00
11		4	Lid for Cover cap M6	43-04811	0.00

BOM ID	IMAGE	QUANTITY	DESCRIPTION	DOCUMENT ID	WEIGHT
12		6	Cover cap M8	43-04813	0.00
13		6	Lid for cover cap M8	43-04816	0.00
14		4	Cover cap M10	43-04818	0.01
15		2	Lid for Cover hat M10	43-04820	0.00
16		4	Countersinking washer plastic 8x21,4x4,5	43-07119	0.00
17		2	Nut, Fujilok-M10-8-RingA2	8008796	0.011
18		4	Nut, Fujilok-M6-8-RingA2	8008794	0.002
19		4	Nut, Fujilok-M8-8-RingA2	8008795	0.006
20		2	Screw, ISO4014-M8x40-8.8	8008349	0.0218
21		2	Screw, ISO4017-M10x25-8.8	8008371	0.0263
22		2	Screw, ISO4017-M8x55-8.8	8008354	0.0277

BOM ID	IMAGE	QUANTITY	DESCRIPTION	DOCUMENT ID	WEIGHT
23		2	Screw, ISO8677-M10x50-8.8	8039294	0.044
24		4	Screw, ISO8677-M6x25-8.8	8008566	0.009
25		2	Screw, ISO8677-M8x45-8.8	8051445	0.025
26		4	Screw, thr-forming M6x25-8.8-(ISO7380)	8027762	0.007
27		4	Screw, wood, TKFT-6x40-8.8	8008651	0.01
28		4	Screw, wood, TKFT-8x60-8.8	8008646	0.02
29		4	Washer, Bolt cap 11x24x2-ISO4759-3-C	8008850	0.006
30		4	Washer, Bolt cap 6.4x14x1.6-ISO4759-3-C	8008848	0.002
31		8	Washer, Bolt cap 9x18x2-ISO4759-3-C	8008849	0.003

